

CITY OF VINELAND

February 20, 2018

REPORT TO: THE MAYOR AND COUNCIL

RE: Street Lighting Recommendations February 2018

Dear Mayor and Members of Council:

Submitted to you herewith are requests for street lighting improvements which are ready for your approval. Copies of the recommendations of the City of Vineland Electric Utility with respect to these requests, along with copies of the drawings identifying the areas in question, are attached for your review.

Should you have any questions pertaining to this matter, please do not hesitate to contact this office.

Respectfully submitted,

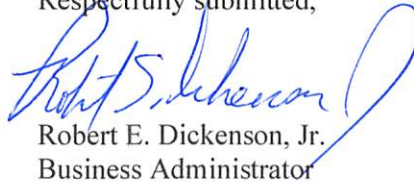

Robert E. Dickenson, Jr.
Business Administrator

/rl

Encls.

cc: John Lillie
Susan Baldosaro

Approved:

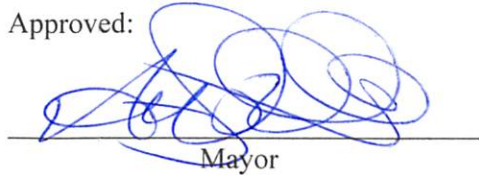

Mayor

2/13/2018

Date

CITY OF VINELAND

STREET LIGHTING RECOMMENDATIONS

FEBRUARY 2018

REQUEST

RECOMMENDATIONS

1. Area of Chestnut Avenue
(between Landis Ave & Delsea Dr)
Drawing No. VMEU-2854
Upgrade eleven (11) existing street lights to 72W LED (relocating three), and one (1) to 108W LED. Install seven (7) additional 72W LED street lights onto existing utility poles.
2. Area of Oak Road
(between Main Rd & Atlantic County Line)
Upgrade nine (9) existing street lights to 72W LED (relocating three), and four (4) to 108W LED. Install eighteen (18) additional 72W LED and three (3) 108W LED street lights onto existing utility poles.
3. Area of Valley Avenue
(between Chestnut Ave & Walnut Rd)
Upgrade eight (8) existing street lights to 72W LED. Install four (4) additional 72W LED street lights onto existing utility poles.
4. Area of Chestnut Avenue
(between City Line and Laurel Ct)
Upgrade eleven (11) existing street lights to 72W LED (relocating three), and one (1) to 108W LED. Install seven (7) additional 72W LED street lights onto existing utility poles.
5. Area of Walnut Road
(between Delsea Dr & West Blvd)
Upgrade six (6) existing street lights to 72W LED (relocating four), and four (4) to 108W LED (relocating one). Install four (4) additional 72W LED and two (2) 108W LED street lights onto existing utility poles.
6. Area of Walnut Rd
(between E Blvd & Main Rd)
Upgrade twelve (12) existing street lights to 72W LED (relocating two), and five (5) to 108W LED (relocating two). Install six (6) additional 72W LED and four (4) 108W LED street lights onto existing utility poles.

VINELAND MUNICIPAL ELECTRIC UTILITY
VINELAND, NEW JERSEY 08360

STREET LIGHT REQUEST

DATE: January 11, 2018

TO: Bob Dickenson 
Business Administrator

RE: Survey at : Area of Chestnut Ave.
between Landis Ave. and Delsea Dr.

PROPOSED BY:

NAME: John T. Boyle

ADDRESS: VMU

The preceding-mentioned location has been surveyed by VMU to ensure proper street lighting in conformance with standard City practice. As a result, we propose the following enhancement(s):

PROPOSED: Upgrade eleven (11) existing street lights to 72W LED (relocating three), and one (1) to 108W LED. Install seven (7) additional 72W LED street lights onto existing utility poles.

Yours truly,

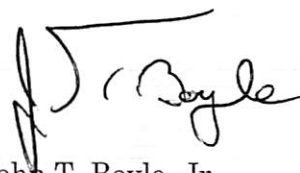



Approved by :

John T. Boyle, Jr.
Assistant General Manager
Vineland Municipal Utilities

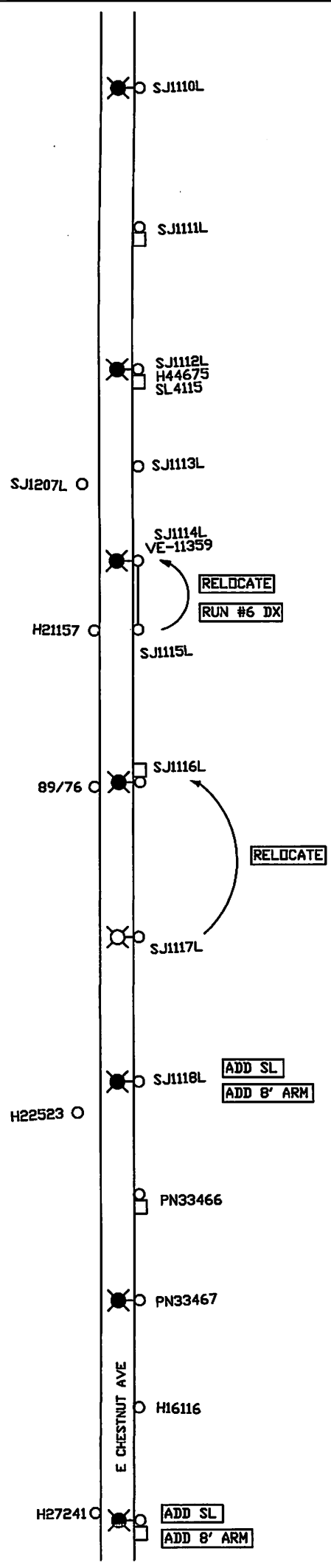
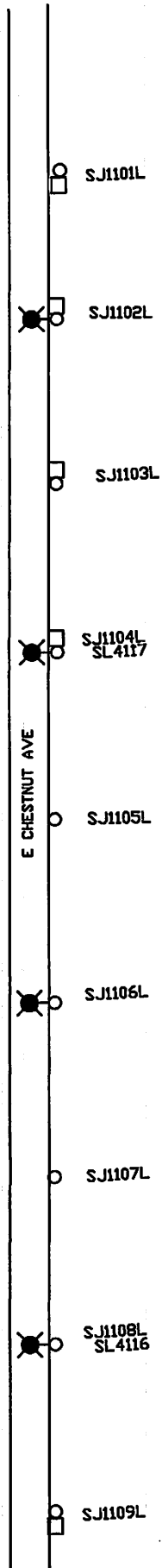
Attachments: DWG.#VMEU-2854



SHEET 1 OF 3

KEY:
 EXISTING SL REMAIN AS IS
 INSTALL/REPLACE W/ (11) 72W LED

PROPOSED STREET LIGHT REVISION AREA OF CHESTNUT AVE. BETWEEN LANDIS AVE. AND DELSEA DR.	
VINELAND MUNICIPAL ELECTRIC UTILITY VINELAND, NEW JERSEY	
DRAWN: EHS	VAULT # F-3-C
DATE: 1/11/2018	DRAWING # VMEU-2854
SCALE: NTS	CHECKED:

DATE	TIME
NO. OF OBSERVATIONS	NO. OF READING
NAME OF OBSERVER	NAME OF ASSISTANT
TITLE OF SURVEY AND SURVEYOR'S NAME AND ADDRESS	
THIS SURVEY WAS MADE FOR THE PURPOSE OF DETERMINING THE POSITION OF THE POINTS MARKED ON THE PLAN	
THE METHOD EMPLOYED WAS THAT OF TRIANGULATION	

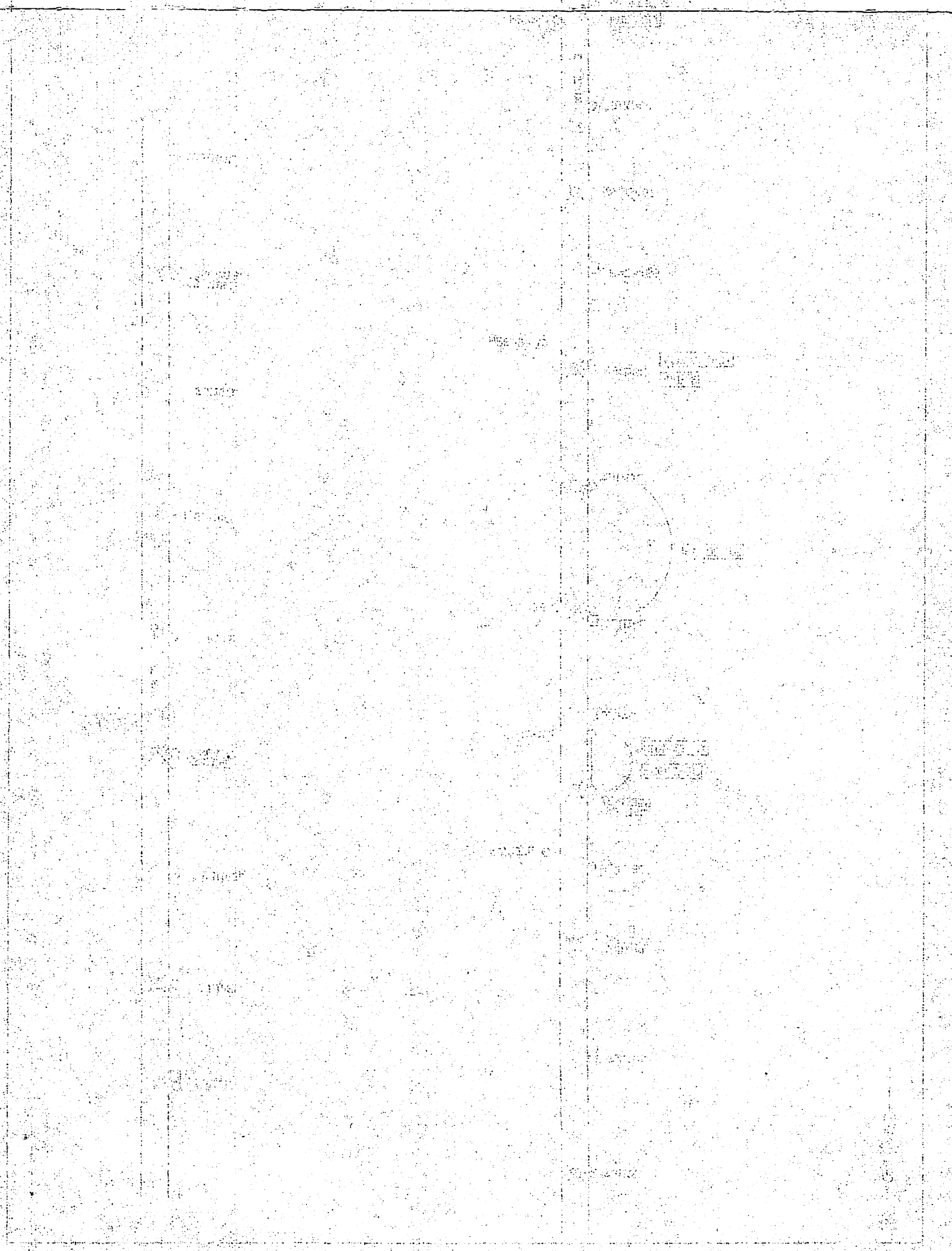

PART I
 GENERAL INFORMATION
 NO. OF SHEETS
 DATE

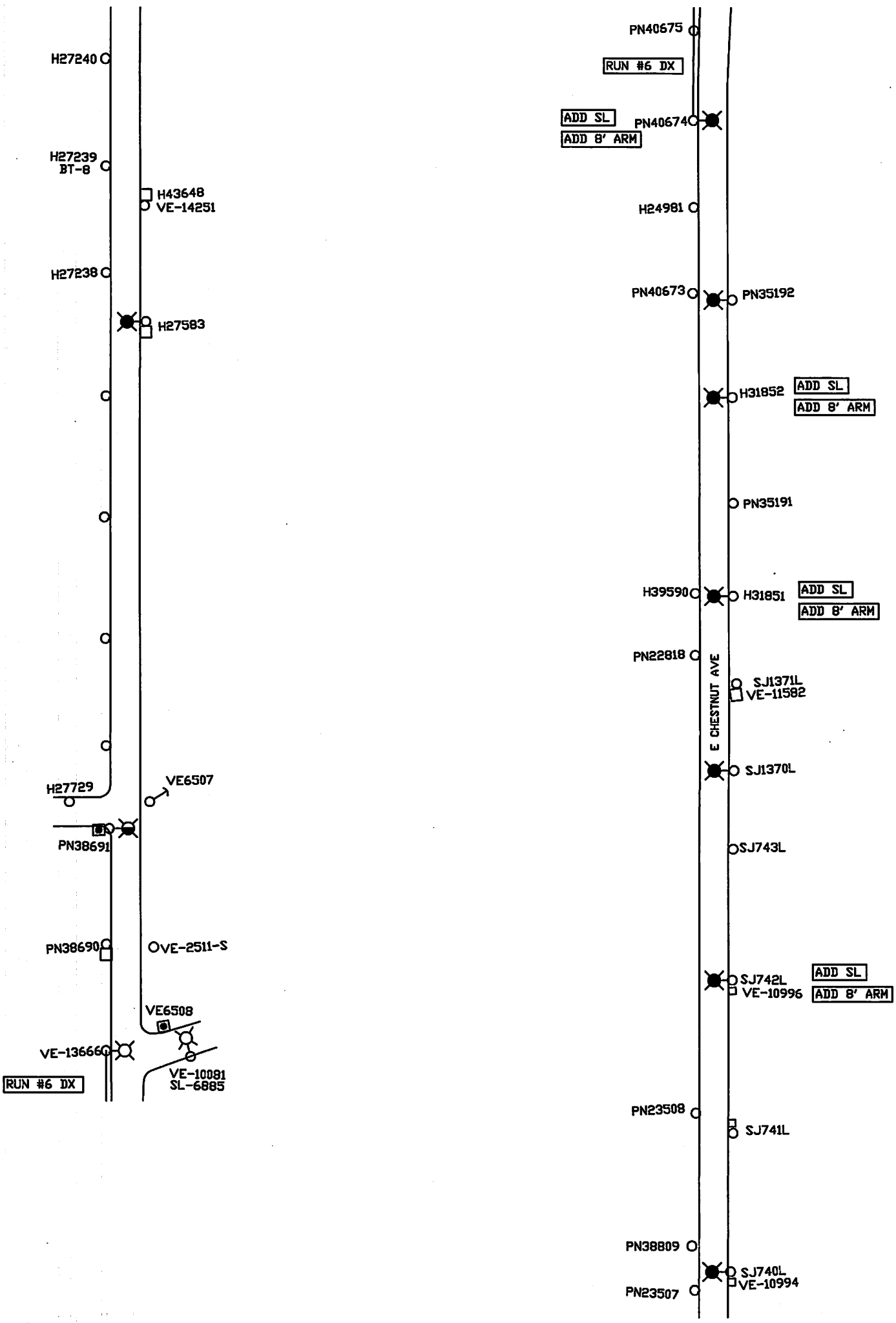



SHEET 2 OF 3

KEY:

-  EXISTING SL REMAIN AS IS
-  INSTALL/REPLACE W/ (8) 72W LED
-  INSTALL/REPLACE W/ (1) 108W LED

PROPOSED STREET LIGHT REVISION
AREA OF CHESTNUT AVE. BETWEEN LANDIS AVE. AND DELSEA DR.

VINELAND MUNICIPAL ELECTRIC UTILITY
VINELAND, NEW JERSEY

DRAWN: EHS

VAULT # F-3-C

DATE: 1/11/2018

DRAWING # VMEU-2854

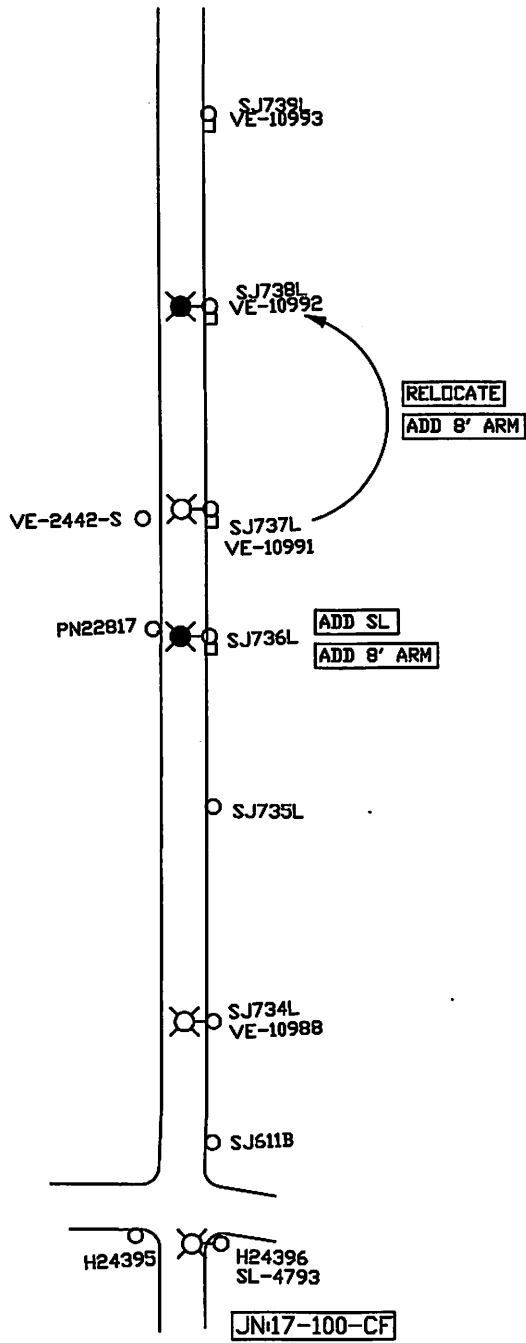

SCALE: NTS

CHECKED: .



SHEET 3 OF 3

KEY:

-  EXISTING SL REMAIN AS IS
-  INSTALL/REPLACE W/ (2) 72W LED

PROPOSED STREET LIGHT REVISION
AREA OF CHESTNUT AVE. BETWEEN LANDIS AVE. AND DELSEA DR.

VINELAND MUNICIPAL ELECTRIC UTILITY
VINELAND, NEW JERSEY

DRAWN: EHS

VAULT # F-3-C

DATE: 1/11/2018

DRAWING # VMEU-2854

SCALE: NTS

CHECKED:

VINELAND MUNICIPAL ELECTRIC UTILITY
VINELAND, NEW JERSEY 08360



STREET LIGHT REQUEST

DATE: February 1, 2018

TO: Bob Dickenson 
Business Administrator

PROPOSED BY:

RE: Survey at : Area of Oak Rd. between
Main Rd. and Atlantic County Line

NAME: John T. Boyle

ADDRESS: VMU

The preceding-mentioned location has been surveyed by VMU to ensure proper street lighting in conformance with standard City practice. As a result, we propose the following enhancement(s):

PROPOSED: Upgrade nine (9) existing street lights to 72W LED (relocating three), and four (4) to 108W LED. Install eighteen (18) additional 72W LED and three (3) 108W LED street lights onto existing utility poles.

Yours truly,

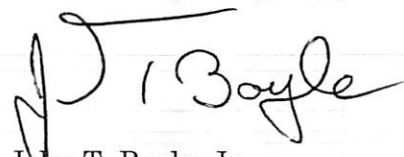

Approved by :

John T. Boyle, Jr.
Assistant General Manager
Vineland Municipal Utilities

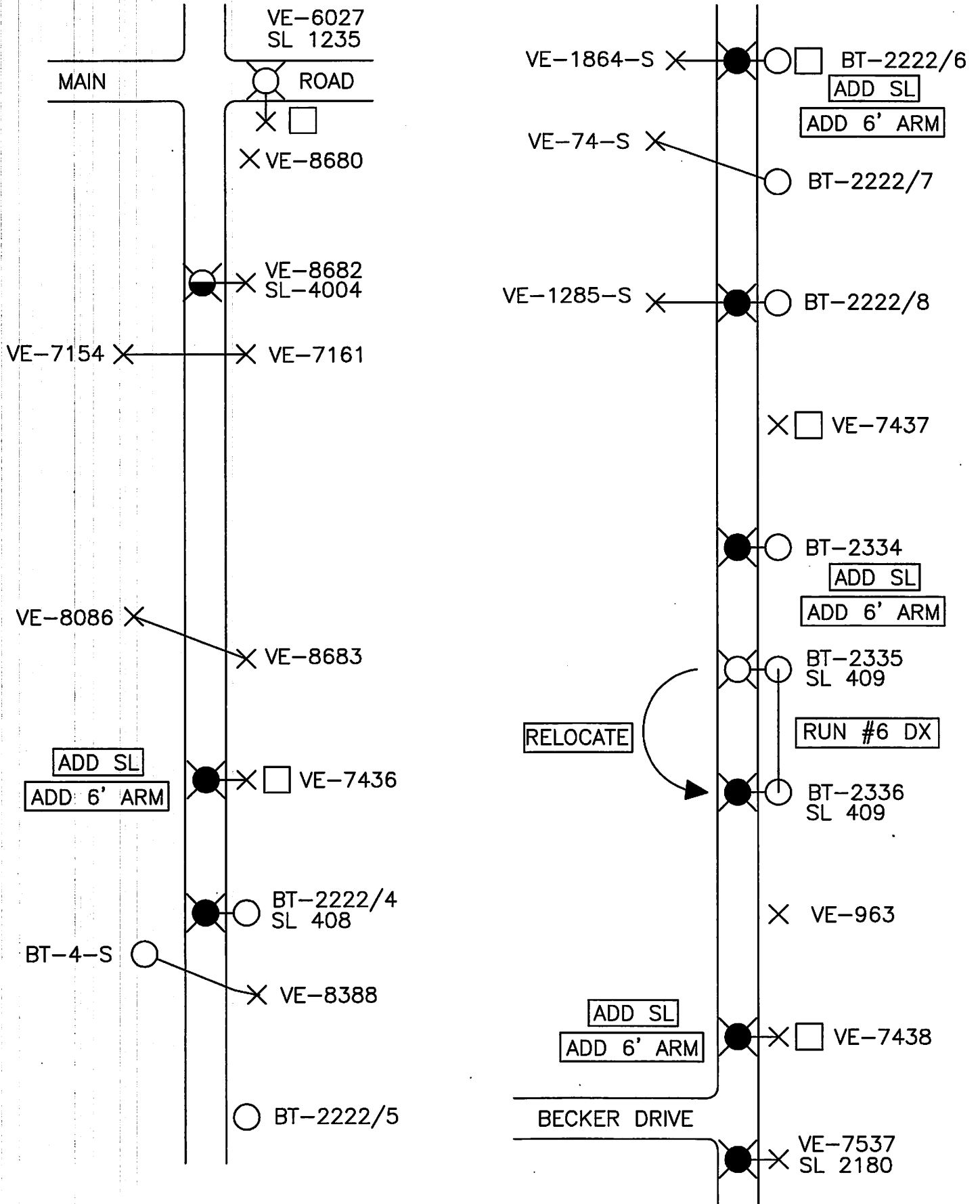
Attachments: DWG.#VMEU-2855



KEY:

-  EXISTING SL REMAIN AS IS
-  INSTALL/REPLACE W/ (8) 72W LED
-  INSTALL/REPLACE W/ (1) 108W LED

SHEET 1 OF 5

PROPOSED STREET LIGHT REVISION
 AREA OF OAK RD. BETWEEN MAIN RD. AND ATLANTIC COUNTY LINE

VINELAND MUNICIPAL ELECTRIC UTILITY
VINELAND, NEW JERSEY

DRAWN: EHS	VAULT # F-3-C
DATE: 2/1/2018	DRAWING # VMEU-2855
SCALE: NTS	CHECKED:

VINELAND MUNICIPAL ELECTRIC UTILITY
VINELAND, NEW JERSEY 08360



STREET LIGHT REQUEST

DATE: February 2, 2018

TO: Bob Dickenson 
Business Administrator

PROPOSED BY:

RE: Survey at : Area of Valley Ave. between NAME: John T. Boyle
Chestnut Ave. and Walnut Rd.

ADDRESS: VMU

The preceding-mentioned location has been surveyed by VMU to ensure proper street lighting in conformance with standard City practice. As a result, we propose the following enhancement(s):

PROPOSED: Upgrade eight (8) existing street lights to 72W LED. Install four (4) additional 72W LED street lights onto existing utility poles.

Yours truly,

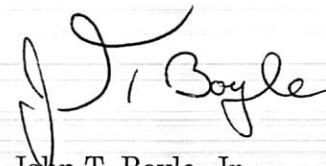



Approved by :

John T. Boyle, Jr.
Assistant General Manager
Vineland Municipal Utilities

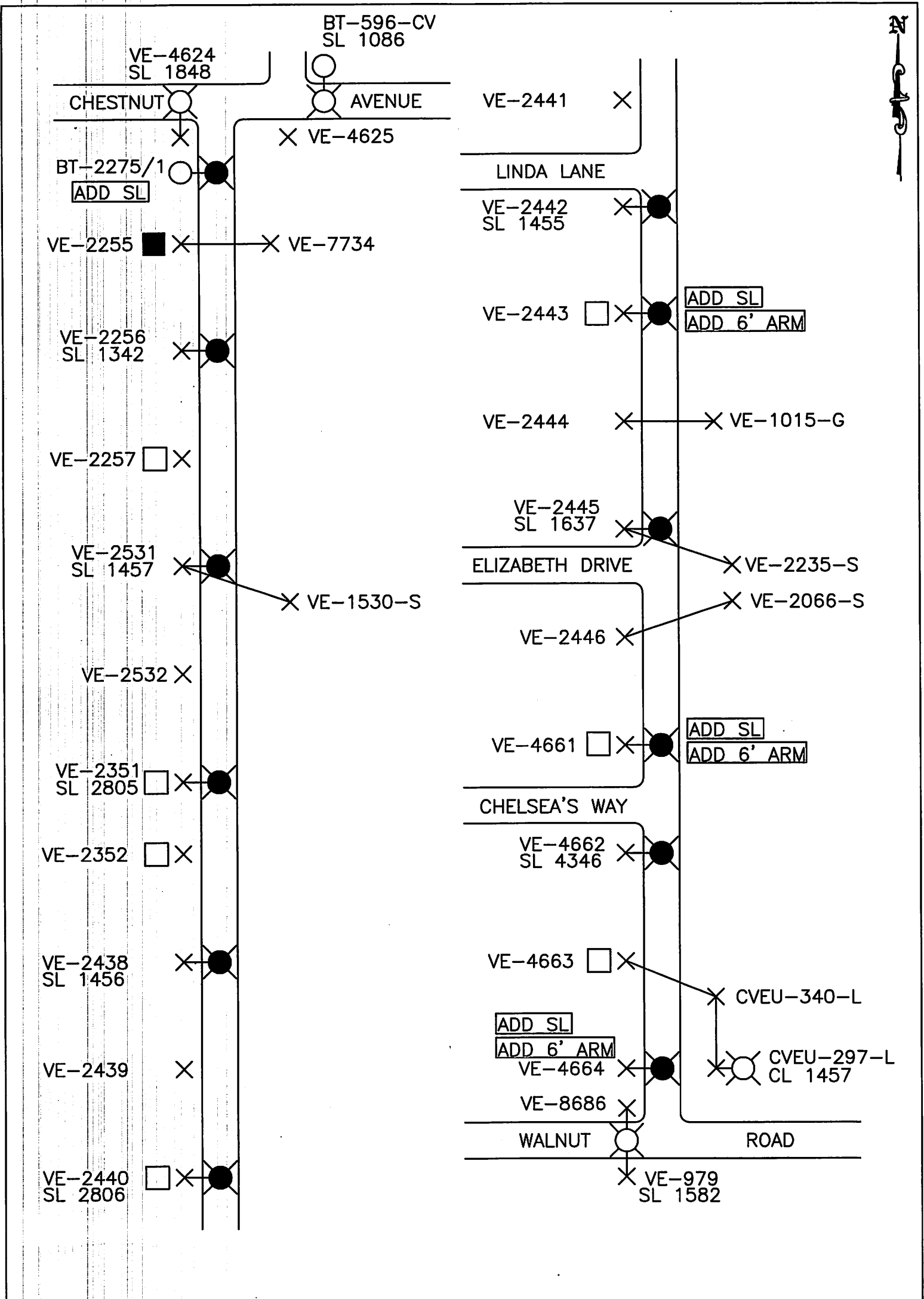
Attachments: DWG.#VMEU-2856



KEY:
 EXISTING SL REMAIN AS IS
 INSTALL/REPLACE W/ (12) 72W LED

PROPOSED STREET LIGHT REVISION
 AREA OF VALLEY AVE. BETWEEN CHESTNUT AVE. AND WALNUT RD.

VINELAND MUNICIPAL ELECTRIC UTILITY
VINELAND, NEW JERSEY

DRAWN: EHS	VAULT # F-3-C
DATE: 2/2/2018	DRAWING # VMEU-2856
SCALE: NTS	CHECKED:

Handwritten notes and markings at the top of the page, including some illegible characters and a faint date.

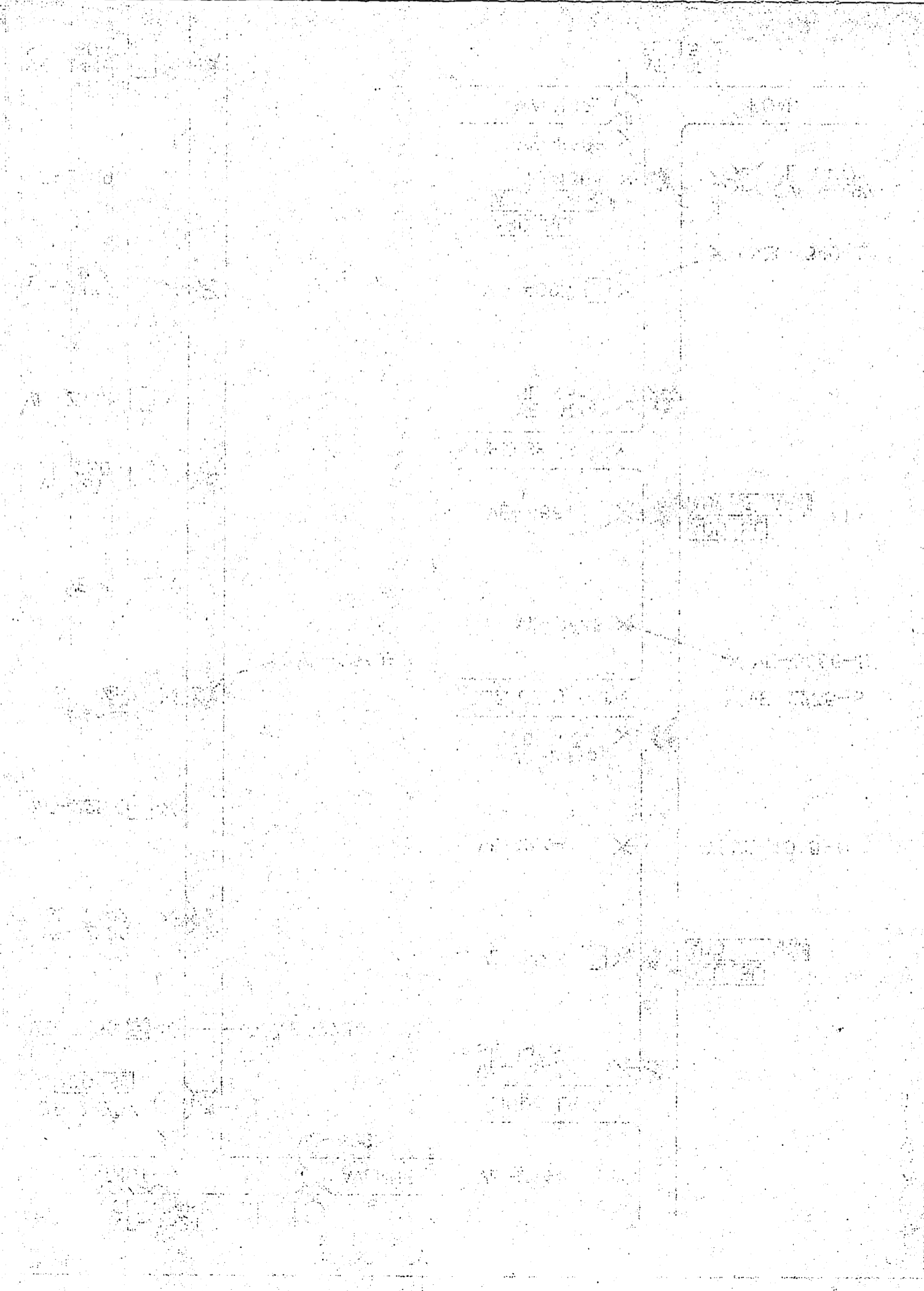

VINELAND MUNICIPAL ELECTRIC UTILITY
VINELAND, NEW JERSEY 08360



STREET LIGHT REQUEST

DATE: January 11, 2018

TO: Bob Dickenson 
Business Administrator

PROPOSED BY:

RE: Survey at : Area of Chestnut Ave.
between City Line and Laurel Ct.

NAME: John T. Boyle

ADDRESS: VMU

The preceding-mentioned location has been surveyed by VMU to ensure proper street lighting in conformance with standard City practice. As a result, we propose the following enhancement(s):

PROPOSED: Upgrade eleven (11) existing street lights to 72W LED (relocating three), and one (1) to 108W LED. Install seven (7) additional 72W LED street lights onto existing utility poles.

Yours truly,

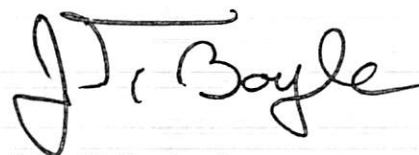

Approved by :

John T. Boyle, Jr.
Assistant General Manager
Vineland Municipal Utilities

Attachments: DWG.#VMEU-2854



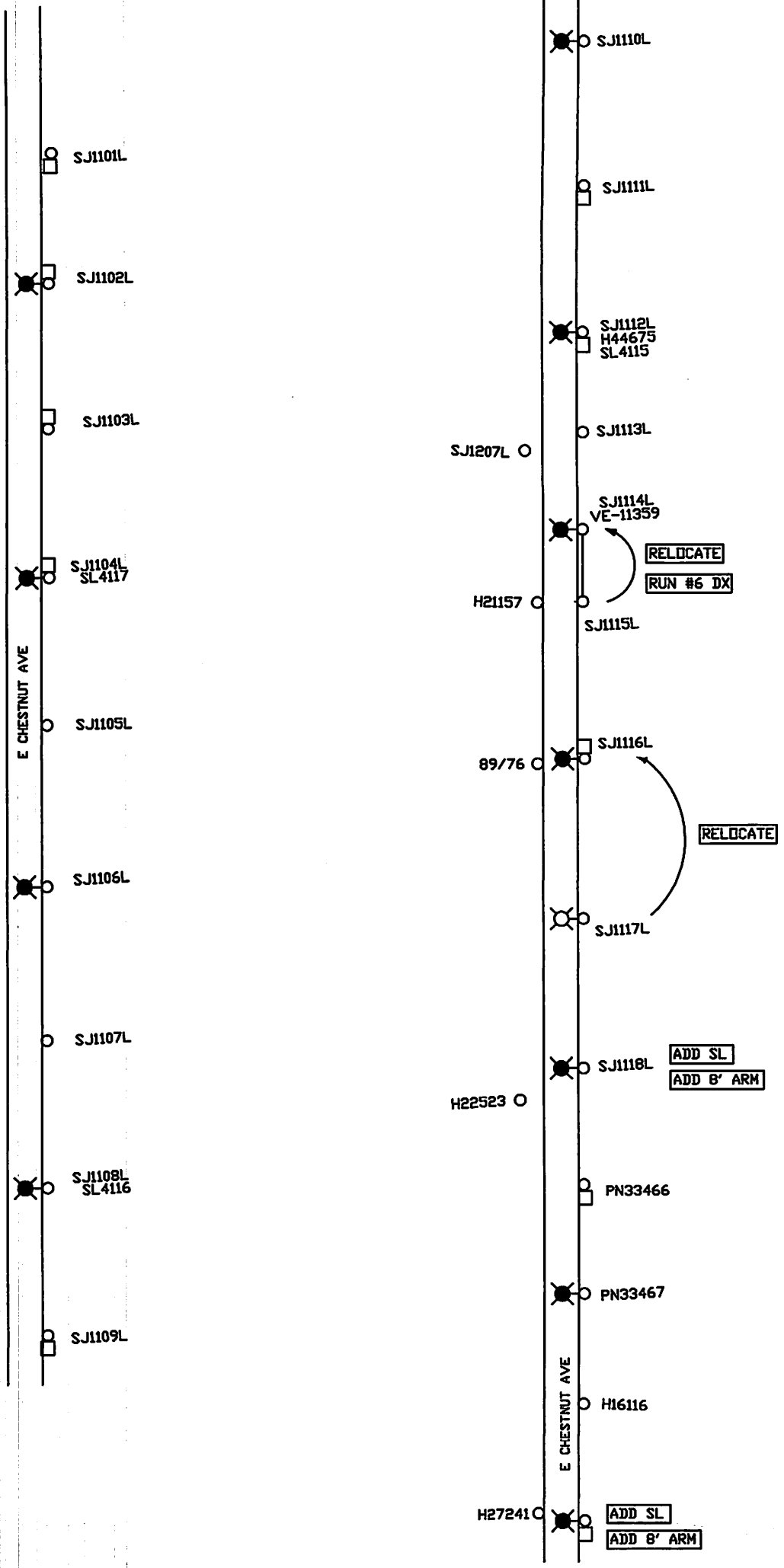

LAST CUST.



SHEET 1 OF 3

KEY:

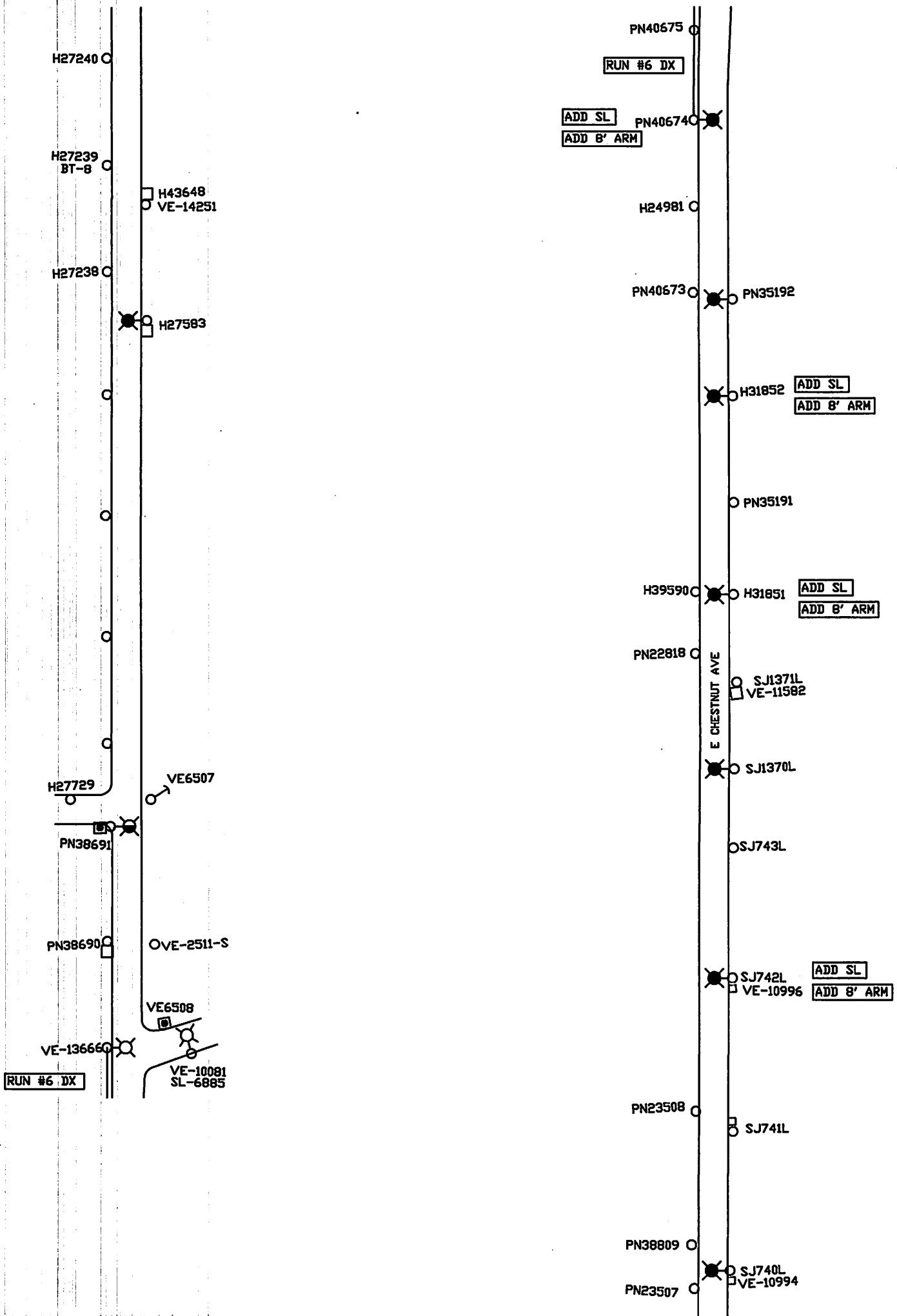

-  EXISTING SL REMAIN AS IS
-  INSTALL/REPLACE W/ (11) 72W LED

PROPOSED STREET LIGHT REVISION AREA OF CHESTNUT AVE. BETWEEN CITY LINE AND LAUREL RD.	
VINELAND MUNICIPAL ELECTRIC UTILITY VINELAND, NEW JERSEY	
DRAWN: EHS	VAULT # F-3-C
DATE: 1/11/2018	DRAWING # VMEU-2854
SCALE: NTS	CHECKED:



SHEET 2 OF 3

KEY:

-  EXISTING SL REMAIN AS IS
-  INSTALL/REPLACE W/ (8) 72W LED
-  INSTALL/REPLACE W/ (1) 108W LED

PROPOSED STREET LIGHT REVISION
 AREA OF CHESTNUT AVE. BETWEEN CITY LINE AND LAUREL RD.

VINELAND MUNICIPAL ELECTRIC UTILITY
VINELAND, NEW JERSEY

DRAWN: EHS

VAULT # F-3-C

DATE: 1/11/2018

DRAWING # VMEU-2854

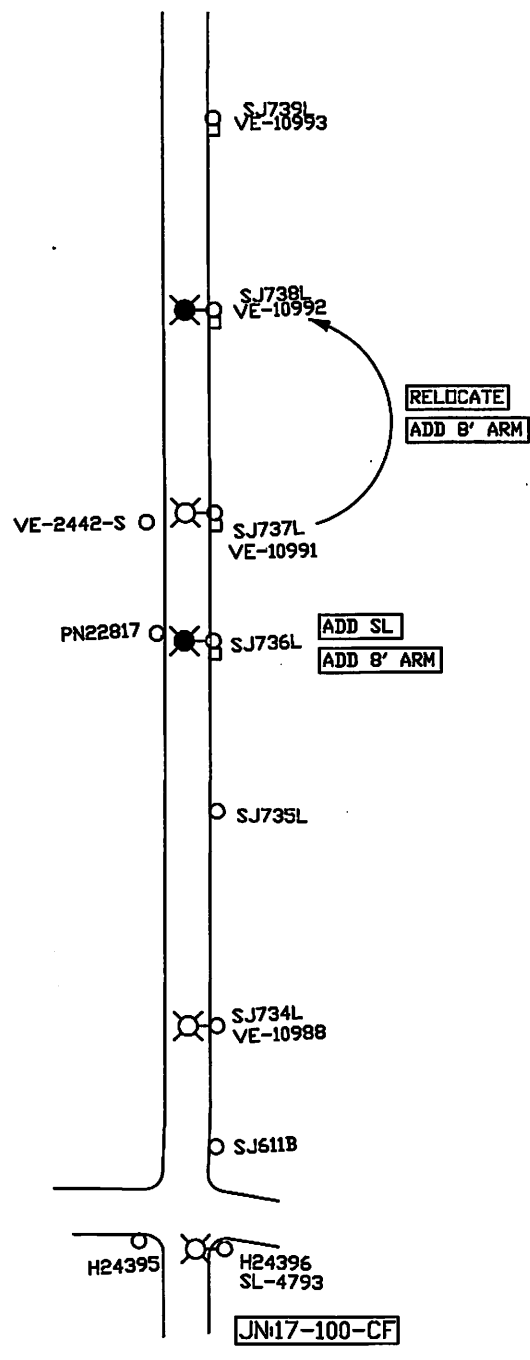

SCALE: NTS

CHECKED:



SHEET 3 OF 3

KEY:

-  EXISTING SL REMAIN AS IS
-  INSTALL/REPLACE W/ (2) 72W LED

PROPOSED STREET LIGHT REVISION AREA OF CHESTNUT AVE. BETWEEN CITY LINE AND LAUREL RD.	
VINELAND MUNICIPAL ELECTRIC UTILITY VINELAND, NEW JERSEY	
DRAWN: EHS	VAULT # F-3-C
DATE: 1/11/2018	DRAWING # VMEU-2854
SCALE: NTS	CHECKED:

VINELAND MUNICIPAL ELECTRIC UTILITY
VINELAND, NEW JERSEY 08360



STREET LIGHT REQUEST

DATE: February 5, 2018

TO: Bob Dickenson 
Business Administrator

PROPOSED BY:

RE: Survey at : Area of Walnut Rd. between Delsea Dr. and West Blvd. NAME: John T. Boyle

ADDRESS: VMU

The preceding-mentioned location has been surveyed by VMU to ensure proper street lighting in conformance with standard City practice. As a result, we propose the following enhancement(s):

PROPOSED: Upgrade six (6) existing street lights to 72W LED (relocating four), and four (4) to 108W LED (relocating one). Install four (4) additional 72W LED and two (2) 108W LED street lights onto existing utility poles.

Yours truly,

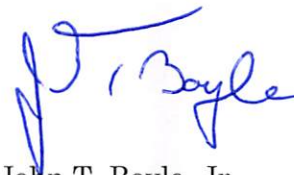

Approved by :

John T. Boyle, Jr.
Assistant General Manager
Vineland Municipal Utilities

Attachments: DWG.#VMEU-2857

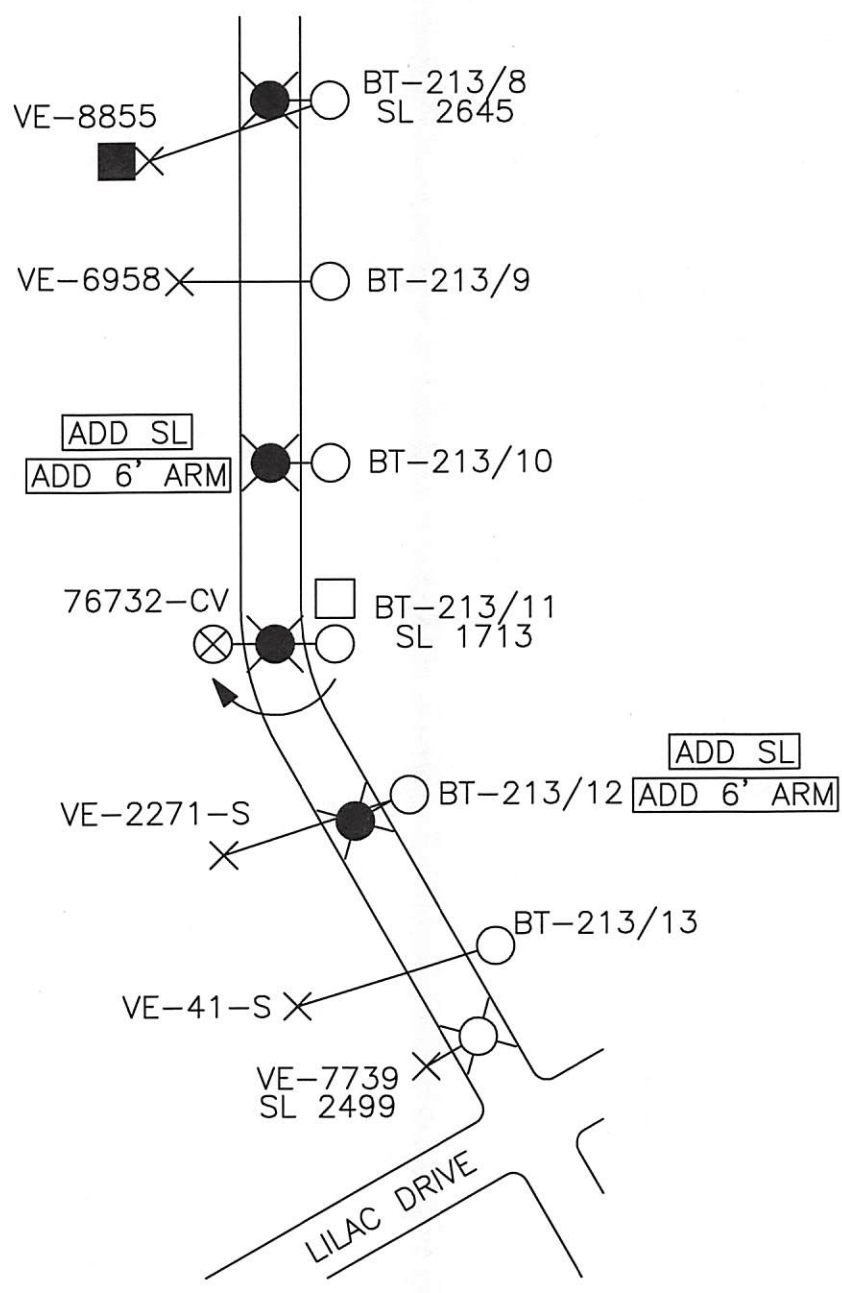
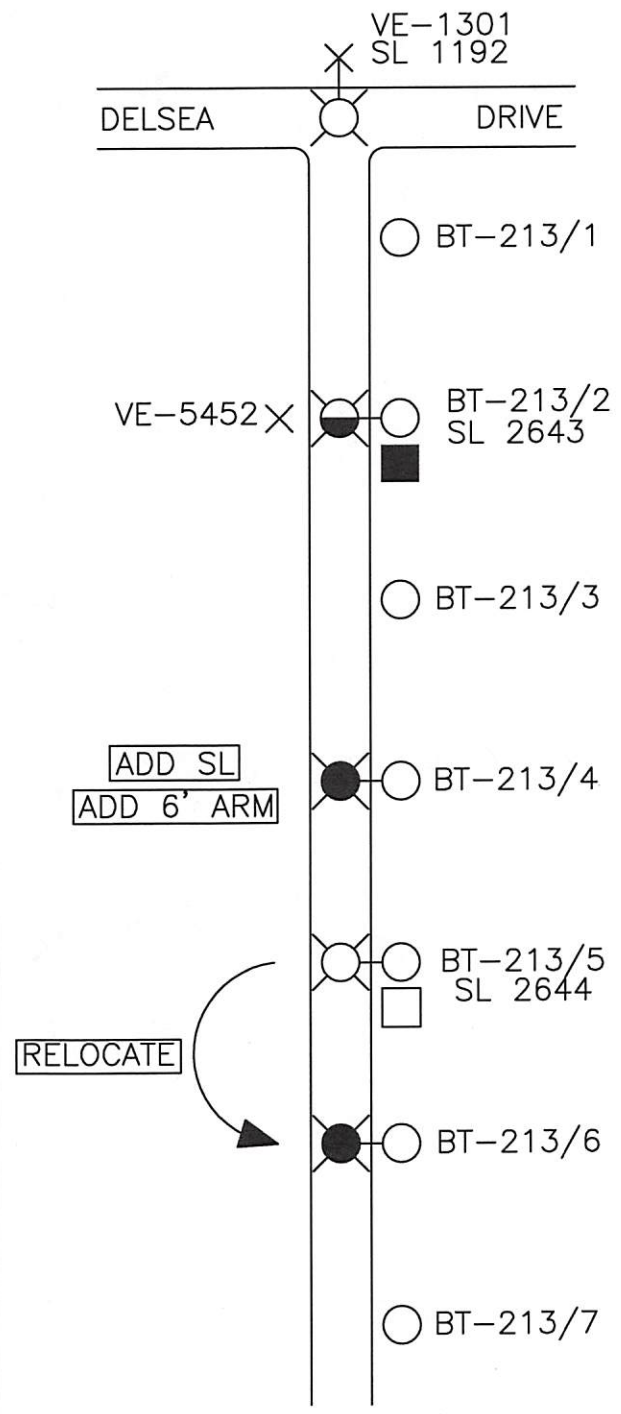

KEY:

	EXISTING SL REMAIN AS IS
	INSTALL/REPLACE W/ (6) 72W LED
	INSTALL/REPLACE W/ (1) 108W LED

SHEET 1 OF 3

PROPOSED STREET LIGHT REVISION AREA OF WALNUT RD. BETWEEN DELSEA DR. AND WEST BLVD.	
VINELAND MUNICIPAL ELECTRIC UTILITY VINELAND, NEW JERSEY	
DRAWN: EHS	VAULT # F-3-C
DATE: 2/5/2018	DRAWING # VMEU-2857
SCALE: NTS	CHECKED:

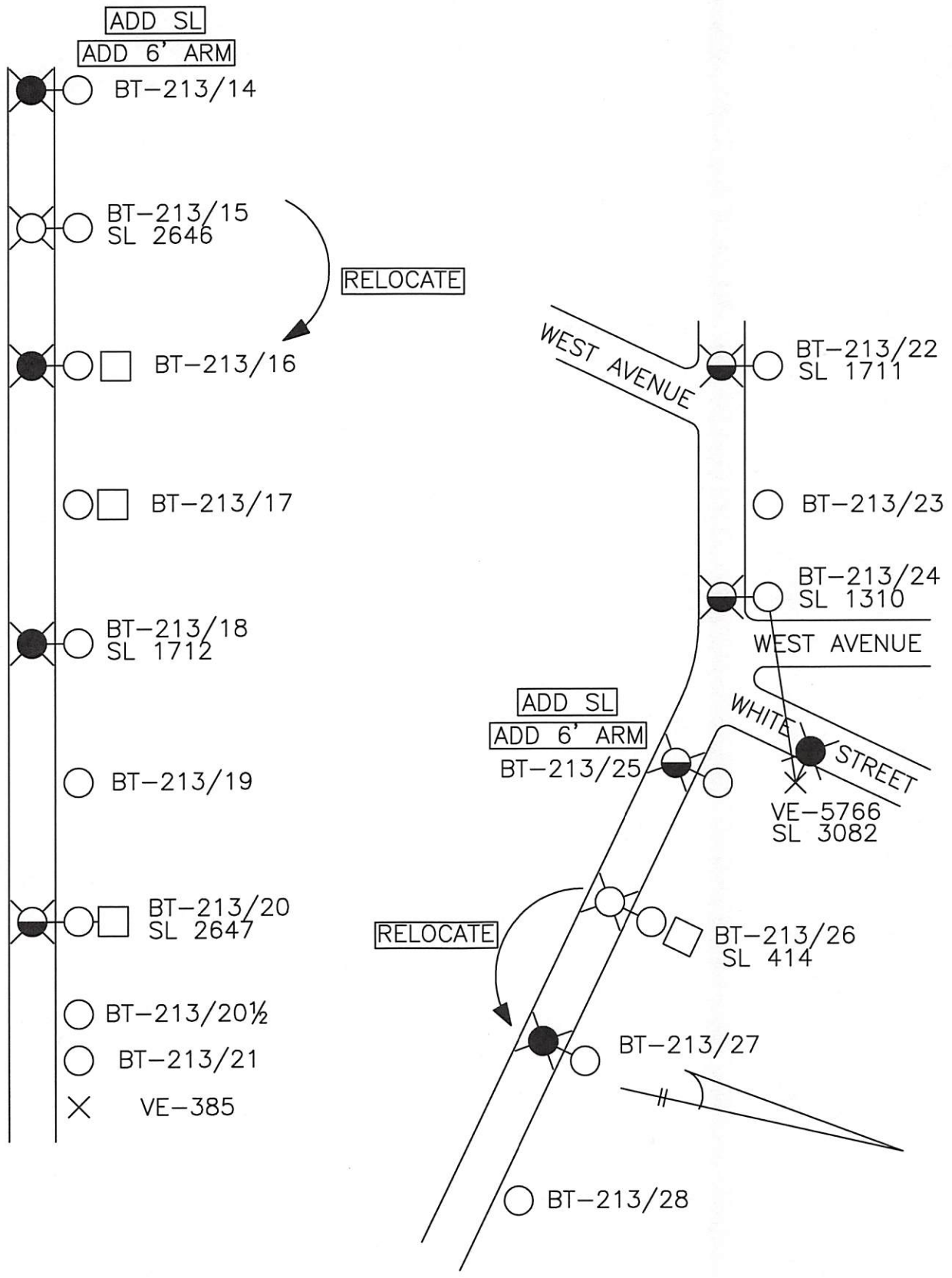

- BT-213/20½
- BT-213/21
- × VE-385

KEY:	
	EXISTING SL REMAIN AS IS
	INSTALL/REPLACE W/ (5) 72W LED
	INSTALL/REPLACE W/ (4) 108W LED

SHEET 2 OF 3

PROPOSED STREET LIGHT REVISION AREA OF WALNUT RD. BETWEEN DELSEA DR. AND WEST BLVD.	
VINELAND MUNICIPAL ELECTRIC UTILITY VINELAND, NEW JERSEY	
DRAWN: EHS	VAULT # F-3-C
DATE: 2/5/2018	DRAWING # VMEU-2857
SCALE: NTS	CHECKED:

STATE OF NEW YORK
IN SENATE
January 10, 1900
REPORT
OF THE
COMMISSIONERS OF THE LAND OFFICE
IN RESPONSE TO A RESOLUTION PASSED BY THE SENATE
MAY 15, 1899

THE COMMISSIONERS OF THE LAND OFFICE
HONORABLE SENATOR
ALBION K. BROWN
ALBANY, N. Y.

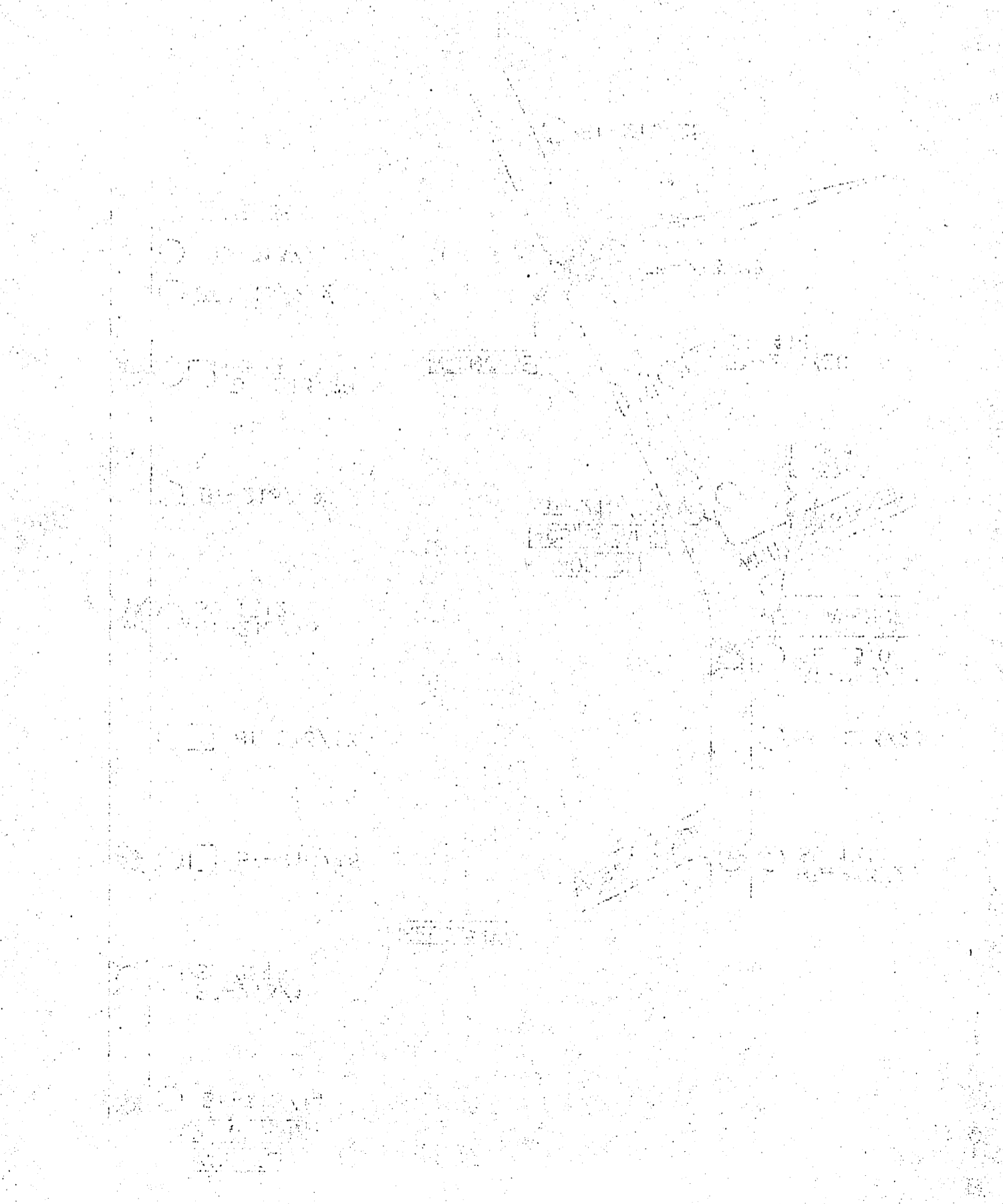

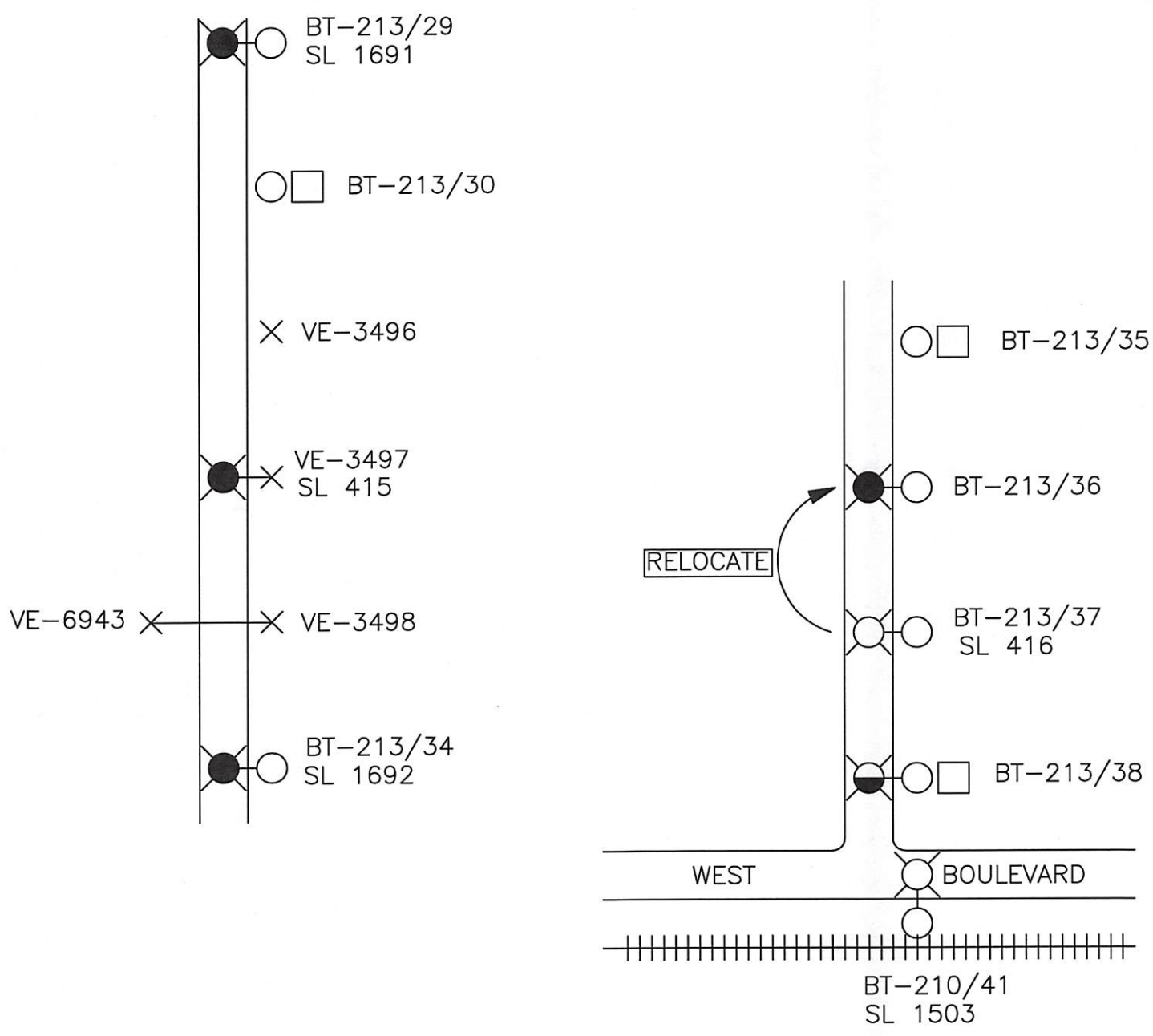

KEY:

	EXISTING SL REMAIN AS IS
	INSTALL/REPLACE W/ (4) 72W LED
	INSTALL/REPLACE W/ (1) 108W LED

SHEET 3 OF 3

PROPOSED STREET LIGHT REVISION AREA OF WALNUT RD. BETWEEN DELSEA DR. AND WEST BLVD.	
VINELAND MUNICIPAL ELECTRIC UTILITY VINELAND, NEW JERSEY	
DRAWN: EHS	VAULT # F-3-C
DATE: 2/5/2018	DRAWING # VMEU-2857
SCALE: NTS	CHECKED:

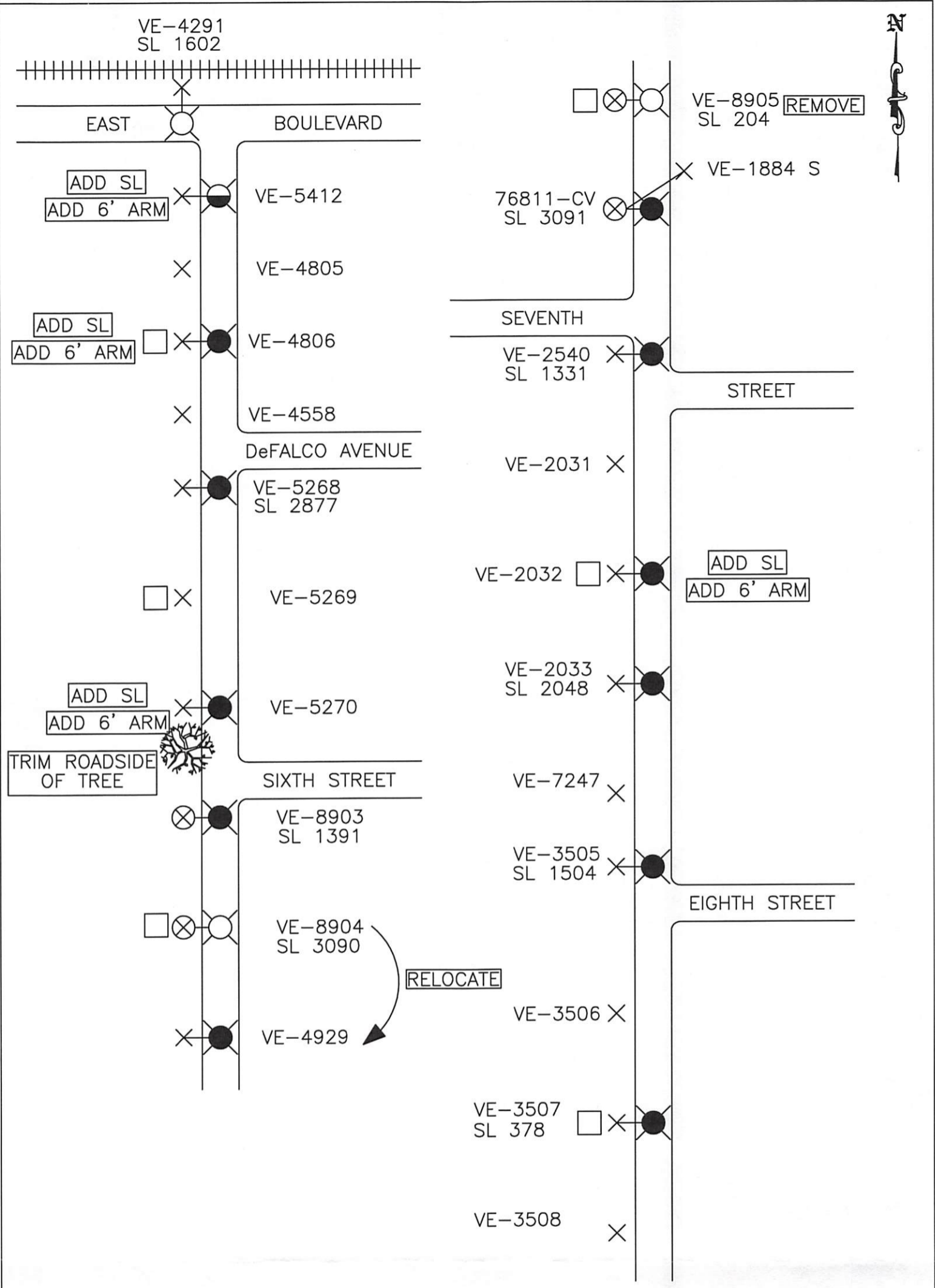

SHEET 1 OF 3

KEY:

	EXISTING SL REMAIN AS IS
	INSTALL/REPLACE W/ (11) 72W LED
	INSTALL/REPLACE W/ (1) 108W LED

PROPOSED STREET LIGHT REVISION AREA OF WALNUT RD. BETWEEN DELSEA DR. AND WEST BLVD.	
VINELAND MUNICIPAL ELECTRIC UTILITY VINELAND, NEW JERSEY	
DRAWN: EHS	VAULT # F-3-C
DATE: 2/5/2018	DRAWING # VMEU-2858
SCALE: NTS	CHECKED: <i>J.M.</i>

10. [Illegible text]

11. [Illegible text]

12. [Illegible text]

13. [Illegible text]

14. [Illegible text]



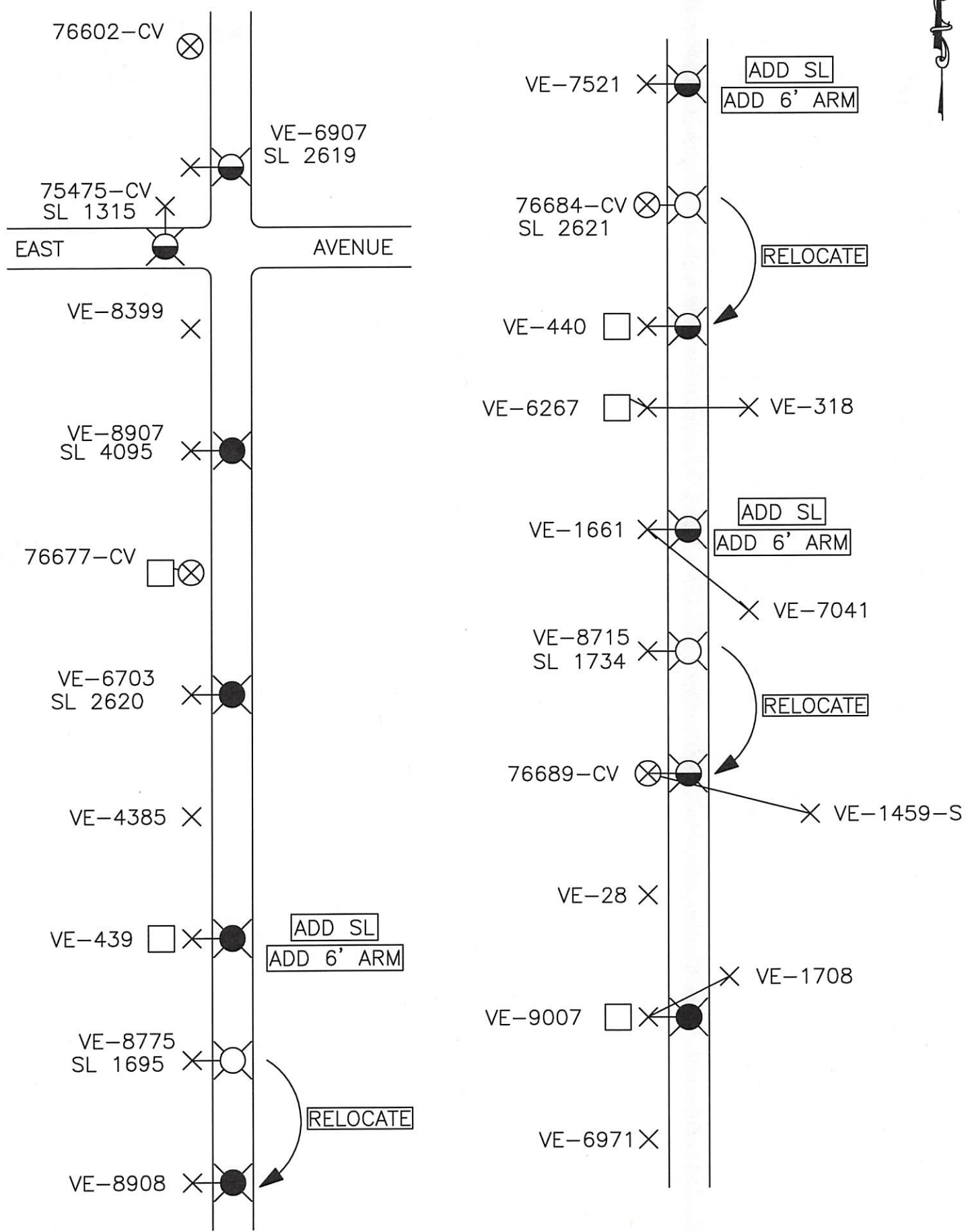

SHEET 2 OF 3

KEY:

	EXISTING SL REMAIN AS IS
	INSTALL/REPLACE W/ (5) 72W LED
	INSTALL/REPLACE W/ (6) 108W LED

PROPOSED STREET LIGHT REVISION AREA OF WALNUT RD. BETWEEN DELSEA DR. AND WEST BLVD.	
VINELAND MUNICIPAL ELECTRIC UTILITY VINELAND, NEW JERSEY	
DRAWN: EHS	VAULT # F-3-C
DATE: 2/5/2018	DRAWING # VMEU-2857
SCALE: NTS	CHECKED:

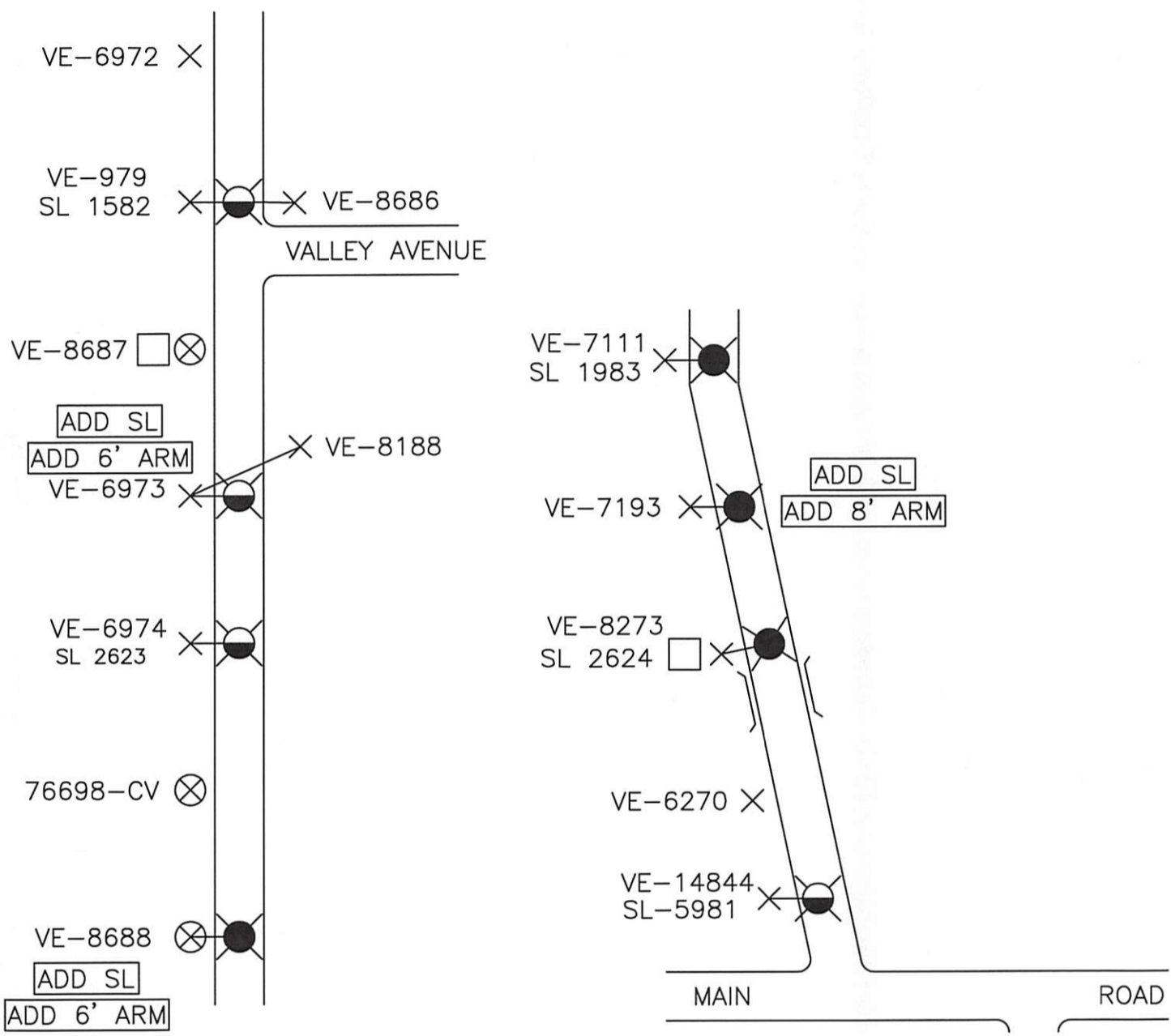

SHEET 3 OF 3

KEY:

	EXISTING SL REMAIN AS IS
	INSTALL/REPLACE W/ (4) 72W LED
	INSTALL/REPLACE W/ (4) 108W LED

PROPOSED STREET LIGHT REVISION AREA OF WALNUT RD. BETWEEN DELSEA DR. AND WEST BLVD.	
VINELAND MUNICIPAL ELECTRIC UTILITY VINELAND, NEW JERSEY	
DRAWN: EHS	VAULT # F-3-C
DATE: 2/5/2018	DRAWING # VMEU-2857
SCALE: NTS	CHECKED: <i>JTS</i>